

Chicken Coop

PROJECT PLAN

YellaWood
Pressure Treated Pine



Start your own local farm with this plan.

Building a Chicken Coop is an ambitious project, but one that is incredibly rewarding. This coop is a deluxe home for chickens with a footprint that's perfect for small and urban backyards.

Its architecture is modern and elemental and includes many features that keep chickens happy. The front opening offers ample pecking and walking room, and the enclosed area provides shelter for roosting and laying. The ramp step

spacing is designed to prevent even small-breed chickens from sliding. There is a slide-out tray for chicken droppings for easy cleanup. Additional hooks can be mounted inside to hang food and water, and outside to store brooms and scoops. The roof is hinged for easy access to lay fresh hay and check on eggs, and its overlapped design protects chickens from rain.

BUILD TIME

10
HRS

DIFFICULTY



COST

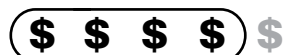

Chicken Coop

IMPORTANT REMINDERS

Read instructions to familiarize yourself with the entire process before beginning.

Always double-check measurements before making cuts – Great Southern Wood is not responsible for incorrect cuts.

Select and use the best faces of boards on the outside of assemblies.

Pre-drill holes before attaching screws. Set $\frac{1}{8}$ " drill bit inside combination countersink bit to appropriate depth for each screw length called for.

Wood glue is optional. If you choose to use it, apply to surfaces before attaching parts, and be sure to wipe up excess with a damp cloth.

Check BuildYella.com for updates to plans and to view the video of this project.

Because wood stock can vary, dry-fit sub-assemblies as needed to ensure dependent parts align. Make any adjustments needed to part dimensions before final assembly.

The Cut List is based on the following actual dimensions for KDAT board stock:

1x2	$\frac{3}{4}$ " x 1 $\frac{1}{2}$ "
1x3	$\frac{3}{4}$ " x 2 $\frac{1}{2}$ "
1x6	$\frac{3}{4}$ " x 5 $\frac{1}{2}$ "
1x8	$\frac{3}{4}$ " x 7 $\frac{1}{4}$ "
$\frac{5}{4}$x6	$\frac{7}{8}$ " x 5 $\frac{1}{4}$ "
2x2	1 $\frac{1}{2}$ " x 1 $\frac{1}{2}$ "
2x4	1 $\frac{3}{8}$ " x 3 $\frac{1}{4}$ "
2x6	1 $\frac{3}{8}$ " x 5 $\frac{1}{4}$ "
2x10	1 $\frac{1}{2}$ " x 9 $\frac{1}{8}$ "
4x4	3 $\frac{1}{4}$ " x 3 $\frac{1}{4}$ "

Chicken Coop

OVERALL SIZE

YellaWood
Pressure Treated Pine

TOP

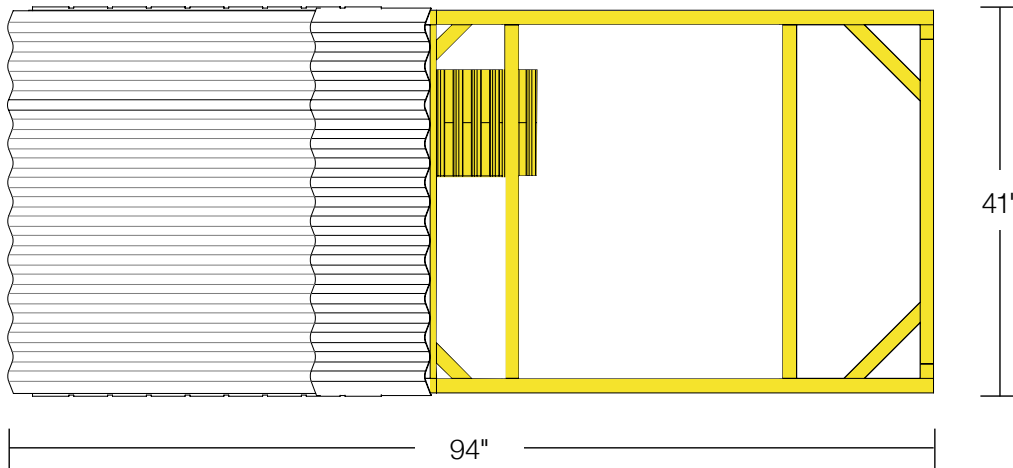

SIDE

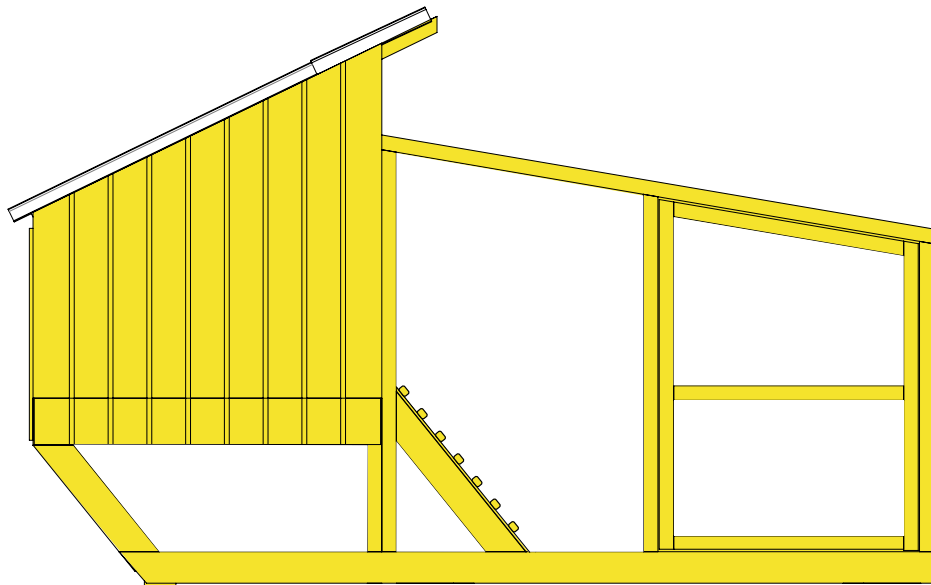

FRONT

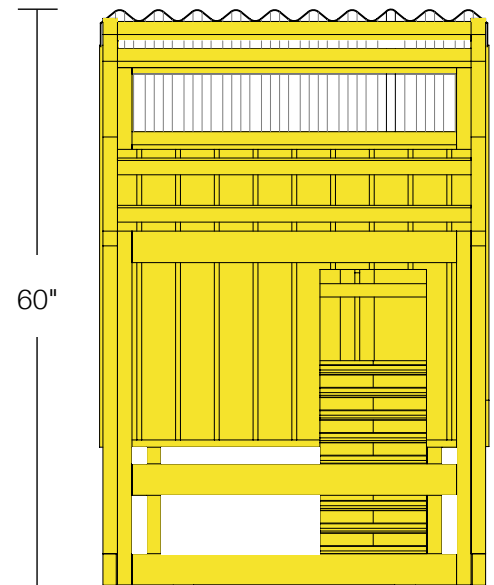

Note: Diagrams not to scale.

Roosting & Nesting Area Parameter Details:

- Roosts should be at least 2" wide and preferably 4". Chickens don't wrap their feet around a perch like wild birds do, and they actually prefer to sleep flat-footed. This has an added benefit of keeping their feet protected from frostbite in the winter.
- Roosts can be as low as a foot off the ground or as high as a foot or so from the ceiling.
- Roosts need to be higher than the nesting boxes or the chickens will be tempted to roost in or on the nesting boxes, looking for the highest perch available. Allow for a length of at least 8" for the roosting rod.

Chicken Coop

OVERVIEW OF STEPS

YellaWood
Pressure Treated Pine

SEQUENCE OF BUILD

1: FRONT FRAME & DOOR

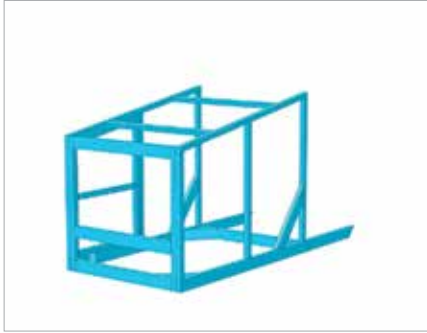

2: BACK FRAME & NESTING BOXES



3: HOUSING, TRAY & ROOSTING BAR



4: ROOFING & RAMP



5: FINISHING & PROTECTION



BUILD TIME

CUTTING

3
HRS

+

ASSEMBLY

5
HRS

+

FINISHING

2
HRS

=

TOTAL

10
HRS

Chicken Coop

WHAT YOU'LL NEED

YellaWood®
Pressure Treated Pine

MATERIALS

- 15x** 2x2x12' YellaWood® brand pressure treated pine
 - 5x** 2x4x12' YellaWood® brand pressure treated pine
 - 2x** 1x3 x8' YellaWood® brand pressure treated pine
 - 2x** 1x2x8' YellaWood® brand pressure treated pine
 - 1x** 5/4x6x8' YellaWood® brand pressure treated pine
-
- 1x** 1⁵/₃₂"x4'x8' plywood
 - 2x** 1⁹/₃₂"x4'x8' T1-11 8" OC siding
 - 2x** 26" x 8' PVC roof panel in white
 - 1x** 14" x 10' aluminum flashing roll
 - 2x** 24" x 50' hardware cloth roll with 1/2" squares
 - 2x** 1 1/2" x 1 1/2" x 10' galvanized steel roof edge flashing

HARDWARE

1/2 LB BOX

- 1/2" washer-head metal screws + appropriate bit
- 1 1/4" gray and 1 1/4" wood screws + appropriate bit
- 1 5/8" wood screws + appropriate bit
- 2 1/2" wood screws + appropriate bit

OTHER

- 1x** 4" galvanized handle
- 1x** 3" galvanized barrel lock
- 2x** 3" galvanized hinges
- 1x** 5 3/4" galvanized handle
- 2x** 4" galvanized hinges
- 1pk** 18-gauge 1/2" staples
- 2x** 1/4" galvanized carriage bolts
- 3x** 1/4" galvanized washers and nuts
- 1x** Construction cement tube

WOOD FINISHING

- YellaWood Protector® Stain and Sealer

SAFETY EQUIPMENT

- Work gloves
- Dust mask
- Safety glasses
- Ear protection

Notes:

Consider using YellaWood® brand KDAT and higher grade products to achieve more professional results.

Choose boards with minimal irregularity to get the most out of the stock. The cut list following shows maximum parts per board. If unsure about board quality, purchase 1 extra piece of each board type.

If you'd like to construct the HACK version of this plan, skip ahead and add this material list to your purchase list.

Chicken Coop

WHAT YOU'LL NEED

YellaWood
Pressure Treated Pine

TOOLS



Pencil



Permanent marker



Measuring tape



Miter saw
(or chop saw)



Pneumatic stapler +
air compressor
(or staple gun)



Table saw

(Optional, but if you need to rip any boards to ensure fit as board dimensions can vary.)



Drill / driver



Jigsaw



1/4" Drill bit



Combination countersink bit
(with 3" long 1/8" bit)



Carpenter square



Heavy-duty scissors



Wire snips



Adjustable wrench

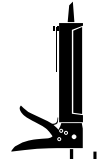

Caulk gun



Clamps
(two at least
5' long)



Level



Radial sander
(or sanding block)



Waterproof wood glue
(optional)



Damp cloth
(optional)



Paint/Stain
Brush

Chicken Coop

CROSS-CUT DIAGRAMS

PREP: CROSS-CUT ALL PARTS

Proceed to cut all parts listed below unless noted otherwise. Be sure to **label all parts** so you know which ones to use for the Assembly Steps that follow.



CROSS-CUT TO	PART	#
30 5/8"	A	3x
84 1/8"	B*	2x
21 3/8"	D*	2x
33 1/2"	F	3x
11 3/8"	H*	4x
16 3/4"	P*	2x
19 3/8"	Q*	2x
39 1/2"	JJ	1x

2x4x12' STOCK 5 BOARDS

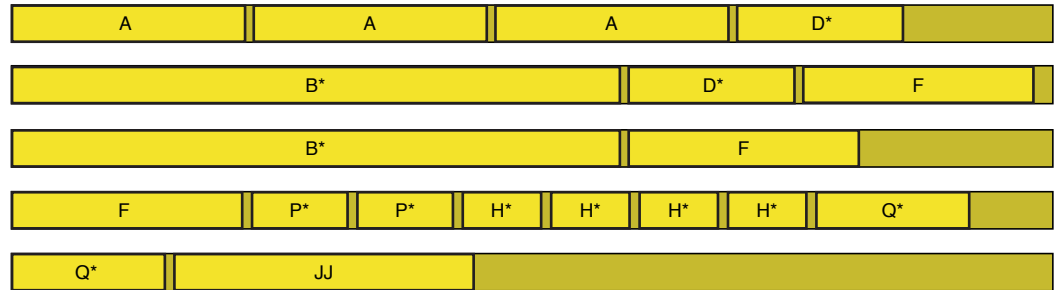

CROSS-CUT TO	PART	#
41 1/2"	C*	2x
36 1/2"	E	2x
32"	G*	2x
58"	I*	2x
37"	J*	2x
36 1/2"	K	8x
23 3/4"	L	2x
36 1/8"	M*	1x
32"	N*	1x
24 3/8"	O*	1x
50 7/8"	R*	2x
33"	S	4x
23 1/8"	T*	2x
45 3/8"	U*	2x
33 1/2"	V	9x
19 3/8"	W	2x
45"	X	3x
14 3/4"	AA	4x
38"	KK	2x
29 1/2"	LL	1x
11"	OO	1x

2x2x12' STOCK 15 BOARDS

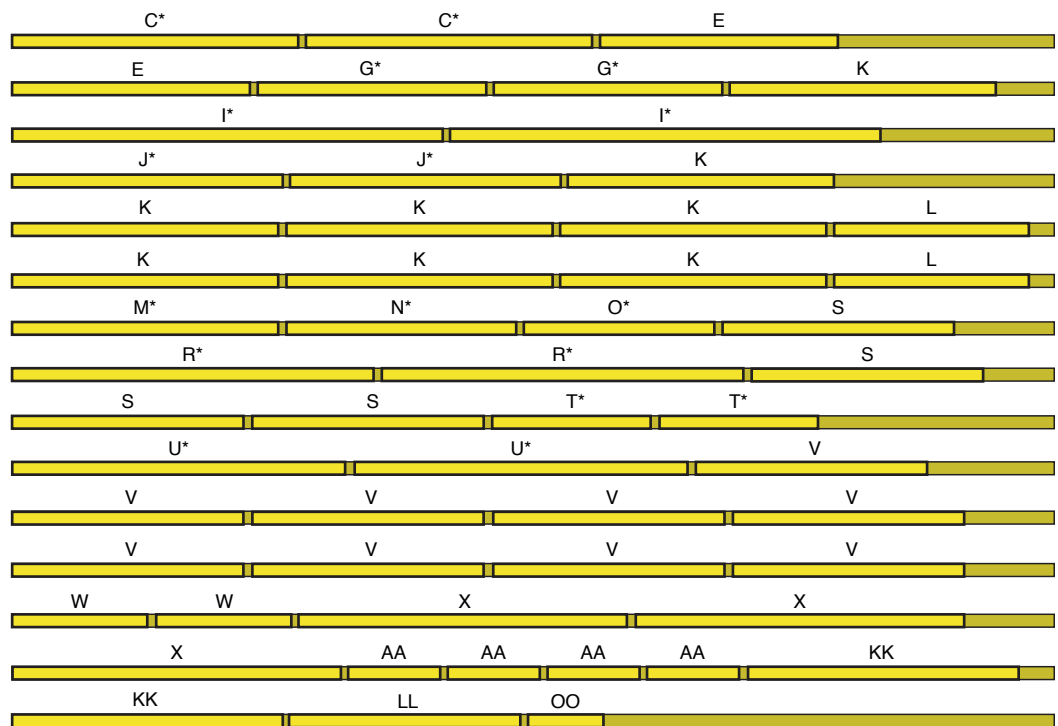

* Requires detail cuts. See following page diagrams.

Note: Diagrams not to scale.

Chicken Coop

CROSS-CUT DIAGRAMS



PREP: CROSS-CUT ALL PARTS

Proceed to cut all parts listed below unless noted otherwise. Be sure to **label all parts** so you know which ones to use for the Assembly Steps that follow.



CROSS-CUT TO	PART	#
32 3/4"	EE	2x
36 1/2"	FF	2x

1x3x8' STOCK 2 BOARDS

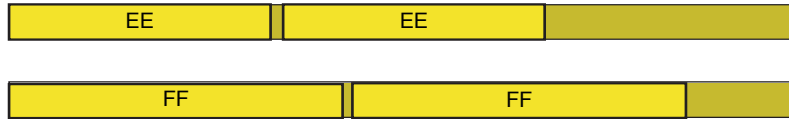

CROSS-CUT TO	PART	#
11"	MM	9x

1x2x8' STOCK 2 BOARDS

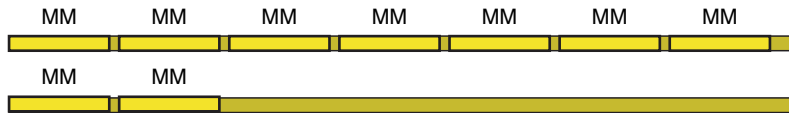

CROSS-CUT TO	PART	#
27"	NN	2x

5/4x6x8' STOCK 1 BOARD



* Requires detail cuts. See following page diagrams.

Note: Diagrams not to scale.

Chicken Coop

DETAIL CUT DIAGRAMS



PREP: DETAIL CUT PARTS



ANGLE CUT

B - DETAIL (FRONT) (x2)



C - DETAIL (FRONT) (x2)



D - DETAIL (FRONT) (x2)

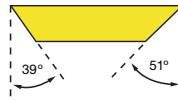

G - DETAIL (FRONT) (x2)



H - DETAIL (FRONT) (x4)

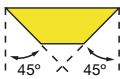

I - DETAIL (FRONT) (x2)

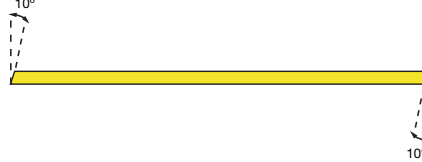

J - DETAIL (FRONT) (x2)



M - DETAIL (FRONT) (x1)



N - DETAIL (FRONT) (x1)



O - DETAIL (FRONT) (x1)

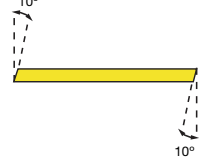

P - DETAIL (FRONT) (x2)

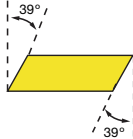

Q - DETAIL (FRONT) (x2)

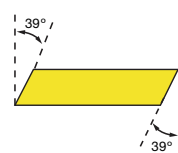

R - DETAIL (FRONT) (x2)

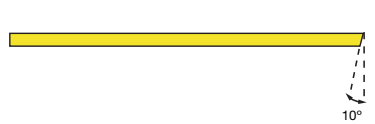

T - DETAIL (FRONT) (x2)



U - DETAIL (FRONT) (x2)

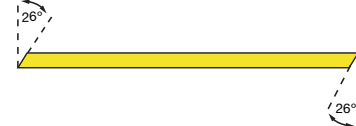

Note: Diagrams not to scale.

Chicken Coop

DETAIL CUT DIAGRAMS



**PREP:
DETAIL CUT
PLYWOOD**



CIRCULAR SAW

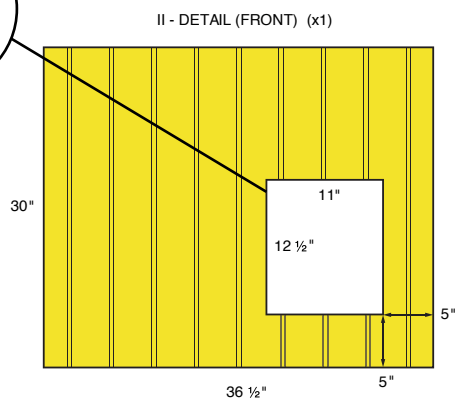
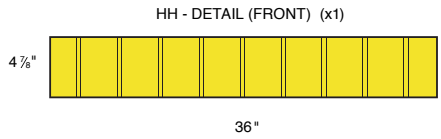
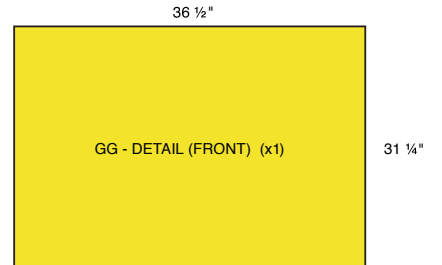
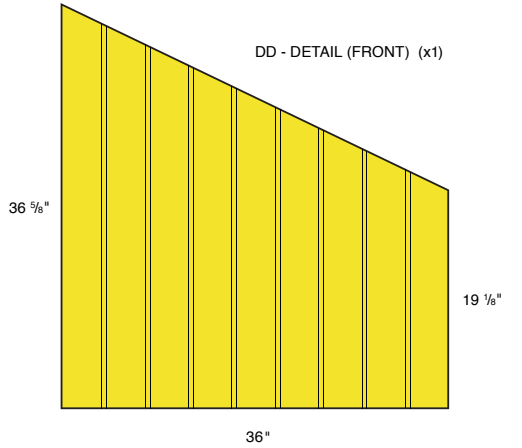
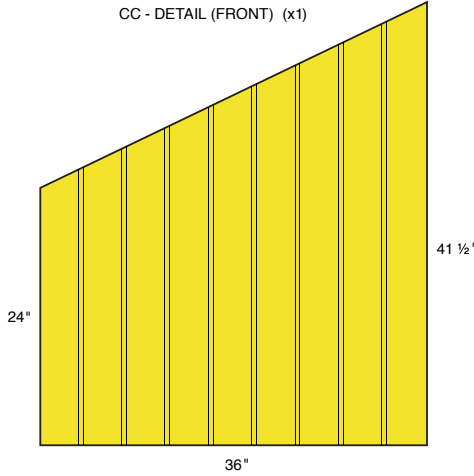
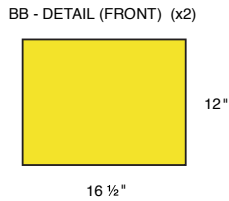
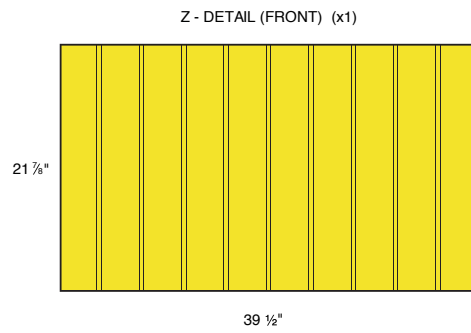
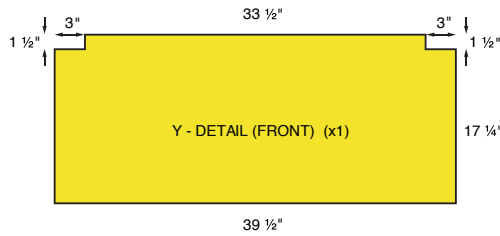

Note: Diagrams not to scale.

Chicken Coop

DIAGRAMS

LAYOUT DIMENSIONS

ROOSTING BAR PLACEMENT

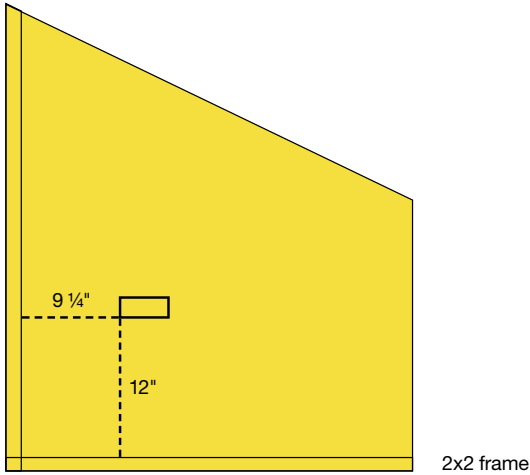

SIDE VIEW OF TRAY AREA

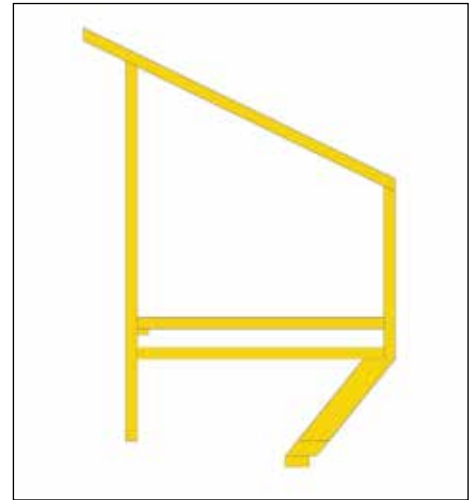

TRAY FRAME LAYOUT



FOUR PARTS (K)

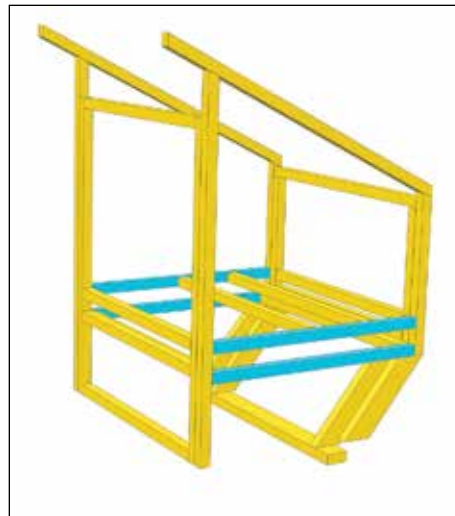

FOUR PARTS (S)



SIX PARTS (V)

The above diagrams show where the same parts are located and their orientation. Assembly may call for the same parts at different times.

Chicken Coop

ASSEMBLY

YellaWood
Pressure Treated Pine

SECTION 1: FRONT FRAME & DOOR

TOOLS



Drill / driver



Pencil



Measuring
tape



Clamps
(at least 5' long)



Combination
countersink bit



Carpenter
square

SUPPLIES



1 5/8" screws

2 1/2" screws

1x 4" galvanized handle

1x 3" barrel lock

2x 3" hinges

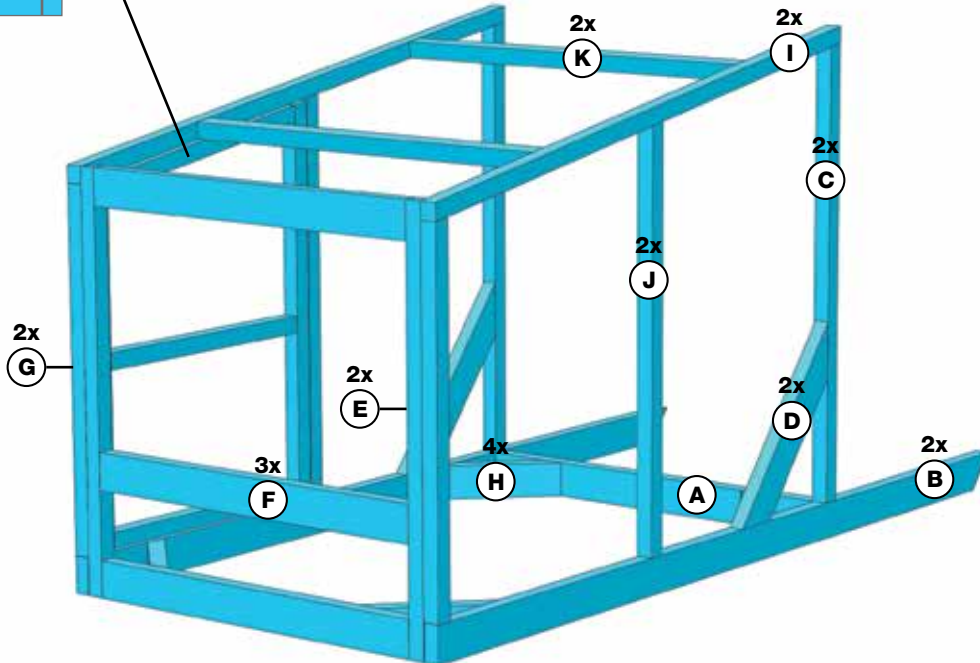
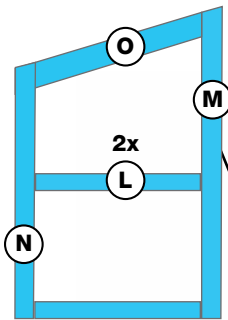

PARTS **A** - **O**

Chicken Coop

ASSEMBLY

SECTION 1: FRONT FRAME & DOOR

1



Begin by placing a Part (A) in between two Parts (B). It measures 55 1/2" from the 90° angle edge of Part (B). Secure (A) to (B) with two 2 1/2" screws per joint.

2



Next, orient a Part (C) so that its flat side is down and the tallest point is facing the angled parts of (B). Attach it at the intersection of (A) and (B), toe-screwing with a 1 5/8" screw. Repeat on the other side.

3



Add braces – Parts (D) – to solidify Part (C). Secure with 2 1/2" screws at an angle at both ends of (D).

4



Form a 90° rectangle with two Parts (E) and three Parts (F). There is a 6" gap between the bottom Part (F) and the middle one. Use two 2 1/2" screws per joint.

5



Place this assembly in between Parts (B) at the 90° edge. Secure to Part (B) using 2 1/2" screws.

6



Add Part (G) on top of Part (B) that is flush with the front of the assembly you just installed. Attach with 2 1/2" screws, avoiding any existing screws. Repeat on the other side.

7



Add Parts (H) at the four corners using two 1 5/8" screws per joint.

8



Top off Parts (C) and (G) with Part (I) so that their edges are flush. Use 2 1/2" screws to secure this end and the other end.

9



Add Parts (J) so they are 27" from Parts (G) and toe-screw into place.

Chicken Coop

ASSEMBLY

SECTION 1: FRONT FRAME & DOOR

10



Secure the top of Part (I) to Part (J) with 2 1/2" screws.

11



Add two horizontal supports, Parts (K), in between Parts (I). Space them 14" from either end. Use two 2 1/2" screws per joint.

12



To build the door, assemble Parts (L) - (O) as shown. Ensure the 90° angles are square and that all edges are flush. Parts (L) and (O) are inside of Parts (M) and (N). Secure two 3" hinges to Part (M), about 5" from its edges.

13



Attach a handle to the short side of the door, Part (N). It is placed 4 1/2" above the middle Part (L).

14



Secure the hinged door frame to the frame with the provided hardware. Use a 1/8" spacer at the bottom of the door to maintain a gap all around the door.

15



Test that the door opens and closes smoothly before attaching all of the hinge screws.

16



Add a barrel lock at the intersection of Part (L) and (G) as shown.

17



Test that the lock functions easily.

Chicken Coop

ASSEMBLY

YellaWood
Pressure Treated Pine

SECTION 2: BACK FRAME & NESTING BOXES

TOOLS



Drill / driver



Pencil



Measuring
tape



Clamps



Combination
countersink bit



Carpenter
square



Level

SUPPLIES



1 5/8" screws

2 1/2" screws

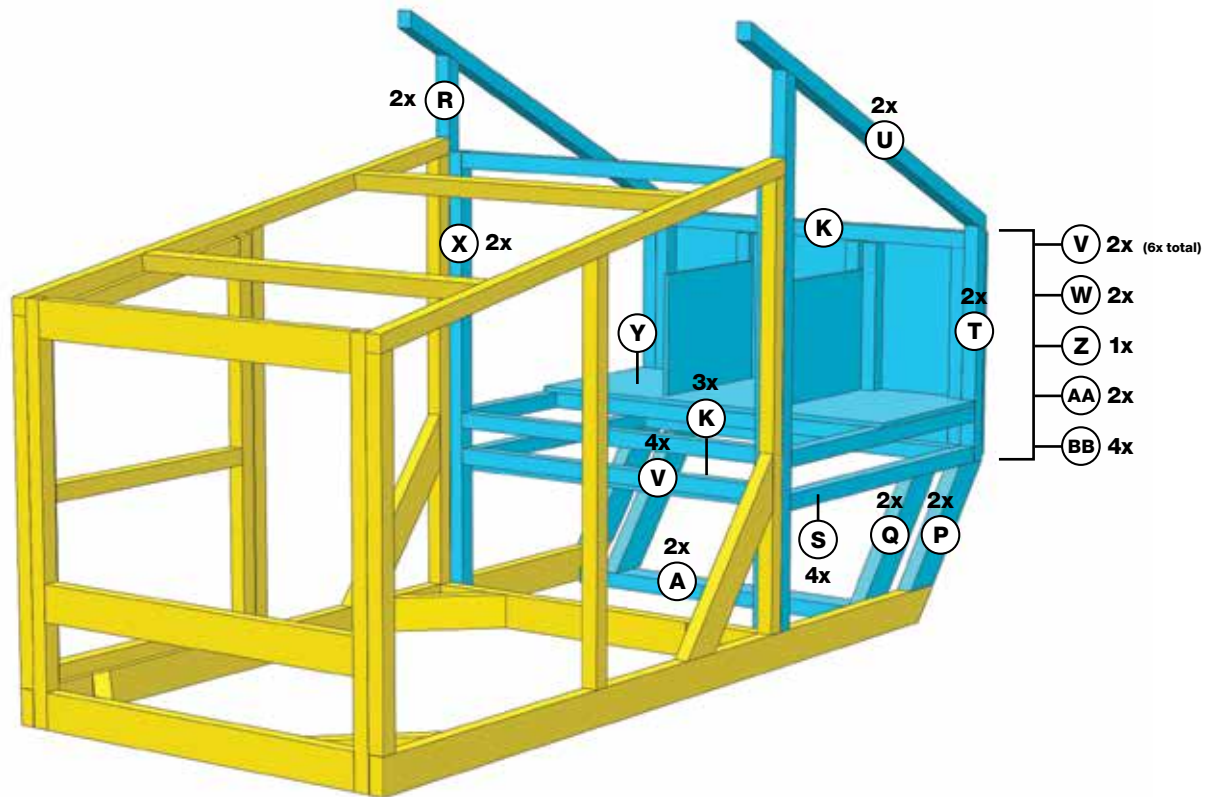

2 MORE PARTS (A) & PARTS (P) - (BB)

Chicken Coop

ASSEMBLY

SECTION 2: BACK FRAME & NESTING BOXES

18



Add a Part (P) to the angled edge of Parts (B) using a 2 ½" screw at an angle. Repeat on opposite side.

19



Add another Part (A) with its wide face down and attach Parts (B) to it on both ends using 2 ½" screws.

20



Place Part (R) directly behind Part (C) oriented so its angled face is toward you, and secure with four 2 ½" screws, working your way up.

21



Finish attaching Part (R) on one side and then repeat on the other.

22



Now you can place a Part (S) on top of Parts (P) and, using a level on top of (S), mark where it is parallel with the ground onto Part (R).

23



Secure (S) into place using 2 ½" screws at an angle. Repeat on the other side.

24



At the other end of (S), add Part (T) so its angled face is toward you.

Note: Part (T) should be about ¼" shy of Part (S), creating a small ledge that will help hold up the back wall when securing in a later step.

25



Place a Part (U) on top of (R) and (T) so it is oriented as shown. Secure with a 2 ½" screw at each joint. Repeat on the other side.

26



Add a second Part (S) above the existing one so that there is a 2 ½" gap between them. This will allow for the tray to slide in (see Page 19, Steps 48-49). Test fit with a 1x3 (on-end) to ensure it slides in snugly but well. Attach with a 2 ½" screw at an angle.

Chicken Coop

ASSEMBLY

YellaWood
Pressure Treated Pine

SECTION 2: BACK FRAME & NESTING BOXES

TIP: REFERENCE PAGE 11 DIAGRAMS

27



Secure the other end of Part (S). Repeat steps 26 - 27 on the other side.

28



Now, place two Parts (Q) 3" from Parts (P). Secure with 2 1/2" screws at an angle.

29



Place a Part (A) on top of these Parts (Q) and secure with two 2 1/2" screws per joint.

30

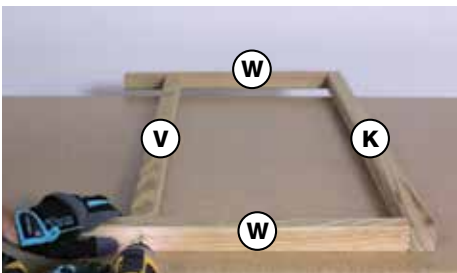

Assemble Parts (K), (V), and (W) on a work surface and create a rectangle as shown. Part (V) should be 2 1/2" up from the edges of Parts (W). Use two 2 1/2" screws per joint.

31



Drop this assembly into place between Parts (T) and secure with a series of 2 1/2" screws.

32

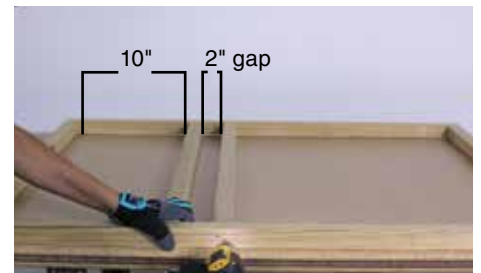

Assemble two Parts (X) and two Parts (W) on a work surface to create a rectangle, ensuring 90° angles, and secure with 2 1/2" screws. Then add two more Parts (V) spaced inside the rectangle as shown.

33



Put this assembly into place as shown and secure with a series of 2 1/2" screws to Parts (R).

34



Add Part (K) so it is flush with the lower Parts (S) and attach.

35



Fill in the top frame with two more Parts (K) as shown. The farthest one is 15 3/4" away from the back Part (V). Then add another Part (V) on top of Part (A) flush with Parts (T) and (W). It will provide a guide for the pull-out tray.

Chicken Coop

ASSEMBLY

SECTION 2: BACK FRAME & NESTING BOXES

TIP: REFERENCE PAGE 11 DIAGRAMS

36



Now, place plywood Part (Y) on top of the frame as shown.

37



Secure with 1 5/8" screws, taking care to not interfere with existing screws.

38



Secure the back wall – Part (Z) – as shown using clamps as needed. Use 1 5/8" screws.

39



Place Parts (AA) and (BB) as shown. Divide the back wall into thirds and evenly space two pairs of Parts (BB). Insert two Parts (AA) between the slots created by Parts (BB).

40



Secure Parts (BB) to the back wall with 1 5/8" screws.

41



Secure Parts (AA) if desired, or leave loose for the flexibility to make a larger nesting box in the future.

Chicken Coop

ASSEMBLY

YellaWood
Pressure Treated Pine

SECTION 3: HOUSING, TRAY, & ROOSTING BAR

TOOLS



Drill / driver



Pencil



Measuring tape



Clamps



Combination countersink bit



Carpenter square



Caulk gun



Wire snips



Permanent marker

SUPPLIES



1 5/8" screws

2 1/2" screws

Construction cement

1x 14" wide metal flashing roll

1x 5 3/4" galvanized handle

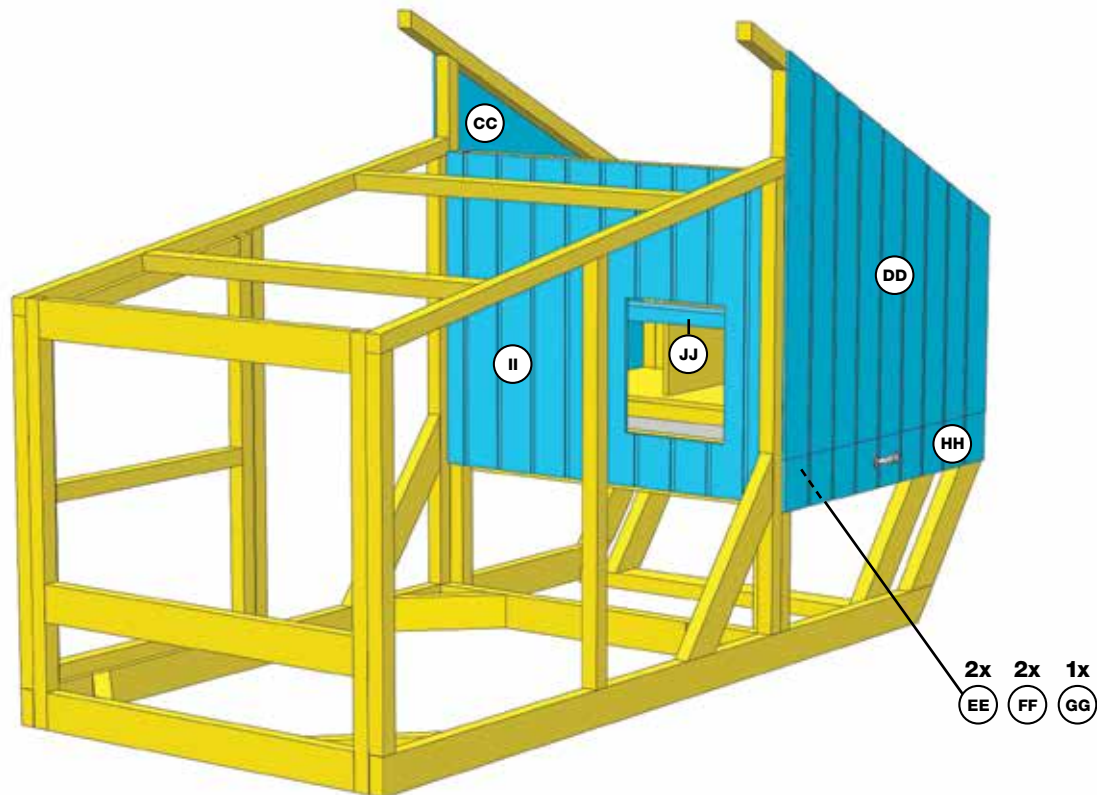

2x EE 2x FF 1x GG

PARTS CC - JJ

Chicken Coop

ASSEMBLY

SECTION 3: HOUSING, TRAY & ROOSTING BAR

42



Lay Part (CC) on the left side and (DD) on the right side of the coop and secure both side walls. Use 1 5/8" screws. Flip the Coop on its side to make securing easier.

43



Next, build a rectangle out of Parts (EE) and (FF), with (GG) plywood as the base. Secure with 1 5/8" screws, being careful to not expose the screw when going into the thin plywood. *This will be the tray, so test-fit again if you'd like into the slots of Parts (S) on the side of the Coop.*

44



Take a 14" wide roll of roof flashing material and cut three pieces to fit within the tray. Use metal cutting snips and cut along the marker line.

45



Adhere each piece of flashing with construction cement.

46

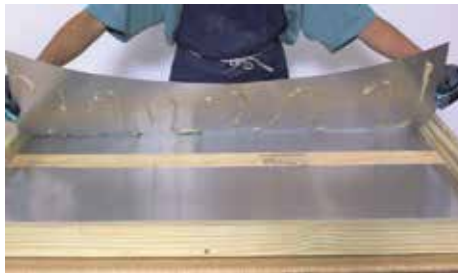

Lay in each piece carefully, with the first two at either end and the third one in the middle.

47



Apply pressure to entire tray surface and let dry the specified amount of time.

48



Once the adhesive is dry, place the tray into the right side and then put Part (HH) onto the front of the tray so it continues the lines from the side wall above. Use four 1 5/8" screws.

49



Attach a handle centered to the front of the tray using the hardware provided.

50



Then, clamp Part (II) into place as the front wall and secure with 1 5/8" screws.

Chicken Coop

ASSEMBLY

SECTION 3: HOUSING, TRAY & ROOSTING BAR

51



For the roosting bar, position Part (JJ) into place using the layout dimensions on the diagrams page and mark its placement with a pencil.

52



Hold and secure from the outside of the two side walls with two 2 1/2" screws.

Chicken Coop

ASSEMBLY

YellaWood
Pressure Treated Pine

SECTION 4: ROOFING & RAMP

TOOLS



Drill / driver



Pencil



Measuring tape



Clamps



Combination countersink bit



Heavy-duty scissors



1/4" Drill bit



Adjustable wrench

SUPPLIES



1 1/4" gray screws

1 1/4" wood screws

2 1/2" screws

2x 1/4" x 4" galvanized carriage bolts, washers, and nuts

2x 4" hinges

PVC roofing material

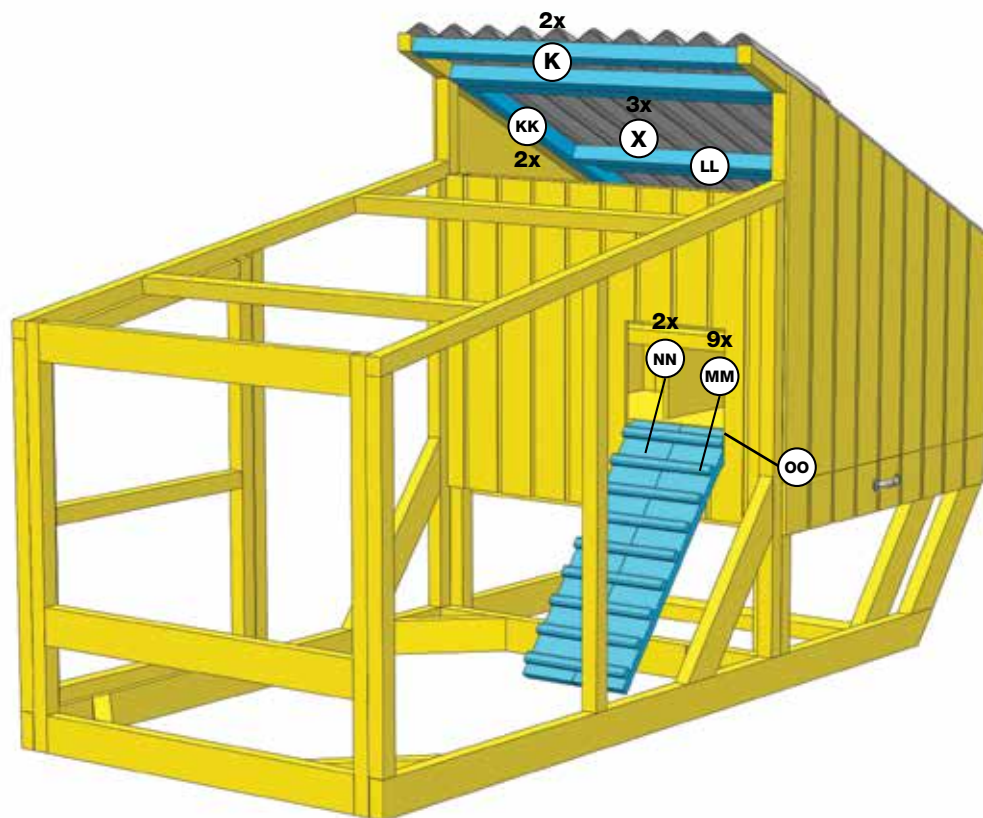

2 MORE PARTS (K) & 3 MORE PARTS (X) & PARTS (KK) - (OO)

Chicken Coop

ASSEMBLY

SECTION 4: ROOFING & RAMP

53



Place Part (K) into place between Parts (U) and directly behind Part (R). Use two 2 1/2" screws at an angle at either end.

54



To make the rotating roof frame, make a rectangle from two Parts (X) and two Parts (KK). Place another Part (X) in the middle.

55



Place two 4" hinges on an outside (X) that is about 4" in from the edges. Use the hardware provided with the hinges.

56



Set the frame into place and, using clamps, secure the other end of the hinge to Part (K).

57



Ensure the frame opens and closes smoothly. It should overhang the back wall so it can be lifted easily.

58



Next, drill a 1/4" hole 2 3/4" in from either end into the middle Part (X).

59



Insert a 1/4" carriage bolt, washer, and nut on both ends.

60



Place Part (LL) up to this Part (X) and pencil-mark where the hole should be drilled so it can fit between the two carriage bolts. It should be about 1/2" from the left side to allow for full motion.

61



Drill through the mark you made at either end of Part (LL) using a 1/4" drill bit.

Chicken Coop

ASSEMBLY

SECTION 4: ROOFING & RAMP

62



Slide one end of Part (LL) onto the right carriage bolt.

63



Then slide on the left side.

64



Add an additional washer and nut on the right side and tighten.

65



Leave the left side open so that Part (LL) can be pulled off and used as a roof prop.

66



It should hit the back wall as shown.

67



Cut the PVC roofing panels to size, ensuring the back overhangs about 2". Secure the portion below the roof hinges first, using 1 1/4" screws. Use gray hardware on the white roof if desired.

68



Work your way down the material, and stick to a consistent pattern of screws for a neat look.

69



Next, add a Part (K) to the front of the roof so it meets the bottom corner of Parts (U). Use two 2 1/2" screws at a diagonal per joint.

70



Lay the top strip of roof material so it overlaps the lower section by about 1" and ensure it overhangs the frame by at least 1/4". Secure in the same manner as the previous portion.

Chicken Coop

ASSEMBLY

SECTION 4: ROOFING & RAMP

71



The overlap is designed so that water will run continuously from the top portion to the bottom portion.

72



When opening the roof, the roof panel rotates up to allow for movement without losing the overlap.

73



Construct the ramp by attaching Parts (MM) to two Parts (NN) so Parts (MM) are flush and square with the edges of (NN). Attach the top and bottom rung first using 1 ¼" wood screws, and then evenly fill in the remaining parts.

74



Flip the ramp over and add final Part (OO) to one end. This will serve as a catch for the ramp to stay in place. Use 2 ½" screws.

75



Drop in the completed ramp into the opening on the front wall.

Chicken Coop

FINISHING



SECTION 5: FINISHING & PROTECTANT

TOOLS



Radial sander
(or sanding block)



Pneumatic
stapler + air
compressor
(or staple gun)



Wire
snips



Paint/Stain
Brush

SUPPLIES

- 1/2" staples
- 1 1/2" x 1 1/2" roof
edge flashing
- Hardware cloth
roll
- YellaWood
Protector®
Stain & Sealer



YellaWood® brand products provide the best available pressure treated lumber protection against rot, fungal decay, and termites. Sanding edges is recommended to reduce snags and splintering. At a minimum, we recommend annual application of a water repellent. You can also paint or stain if you prefer.

76

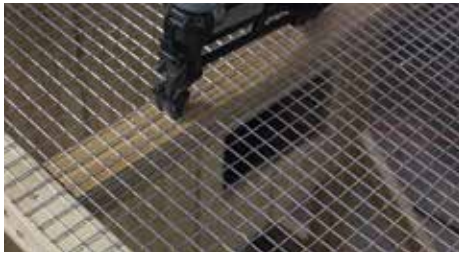

To protect the chickens, lay out and attach hardware cloth to the frame using 1/2" staples and a staple gun.

77



Cut the hardware cloth to size with wire snips as you work your way around the coop.

78



Protect the door separately so it can be opened and closed. Secure the open portion below the ramp as well.

79



Complete protecting the enclosure with hardware cloth as shown.

80



Next, flip the coop on its side and attach angled flashing to encase all of the bottom edges.

81

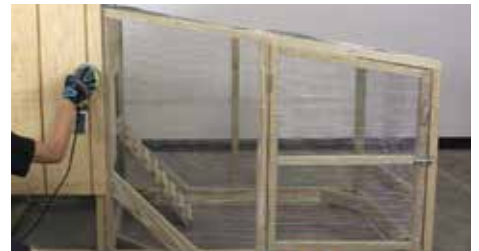

Finally, ease any sharp edges using a radial sander or sanding block with medium grit. Apply preferred finish to the wood.

82



We recommend long lasting YellaWood Protector® semi-transparent stain and water repellent wood sealer, the only stain backed by the famous Yella Tag. Follow manufacturer's recommendations for application.

Chicken Coop

GALLERY OF IMAGES

YellaWood
Pressure Treated Pine



Note:

After you find a good place for the coop, build up the ground around any gaps you see to prevent rodents and snakes from being able to get under the structure.



Chicken Coop // Hack

PROJECT PLAN

YellaWood
Pressure Treated Pine



Make relocating your chickens simple and easy.

A simple and fun hack to this project includes adding two 10" wheels to the back-angled 2x4s.

Placing the wheels between the two angled braces and then securing them with bolts is almost all that's needed for this enhancement.

Then you just add handles to the front beam and you've got yourself a "cooped-up" wheel barrow.

BUILD TIME

1
HR

DIFFICULTY



COST



Chicken Coop // Hack

YellaWood
Pressure Treated Pine

OVERVIEW OF STEPS

SEQUENCE OF BUILD

1: INSTALL WHEELS



2: INSTALL FRONT HANDLES



WHAT YOU'LL NEED

HARDWARE

- 2x** 3 1/2" zinc-plated storage chest handles

OTHER

- 2x** 10" x 2 3/4" wheel for hand trucks + corresponding washers, nuts, and bolts that fit inner diameter of wheels

TOOLS



Pencil



Measuring tape



Drill / driver



Drill bit that fits internal wheel diameter



Carpenter square



Metal snips

SAFETY EQUIPMENT

- Work gloves
- Dust mask
- Safety glasses
- Ear protection

BUILD TIME

CUTTING

1/2
HR

+

ASSEMBLY

1/2
HR

=

TOTAL

1
HR

IN JUST

4
STEPS

Chicken Coop // Hack

YellaWood
Pressure Treated Pine

ASSEMBLY

INSTRUCTIONS FOR ALL SECTIONS

1

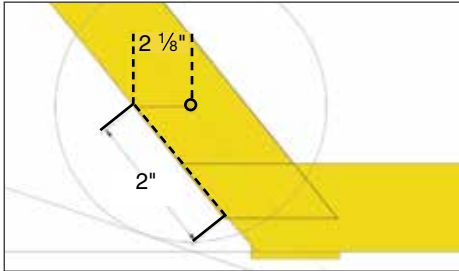

Measure and mark a point as shown on both of the inside Parts (Q)s. Transfer these marks to Parts (P) so they are parallel with the ground.

2

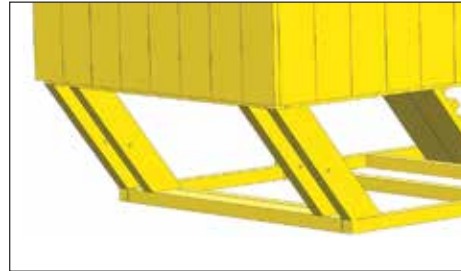

Drill these with a drill bit that accommodates the center hole on the wheels you chose. It should be close to 1/2".

3



Insert 10" wheels in between Parts (P) and (Q) and secure with appropriately sized carriage bolts, washers, and nuts.

4

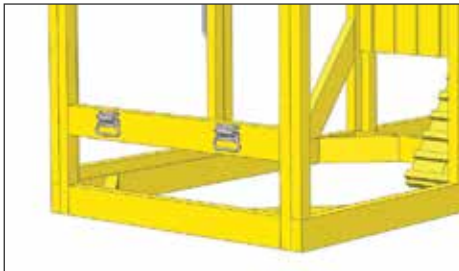

Remove a portion of existing hardware cloth on Part (F) to allow for the handles to sit flush. Install the handles using the hardware provided.

UTILIZING HACK

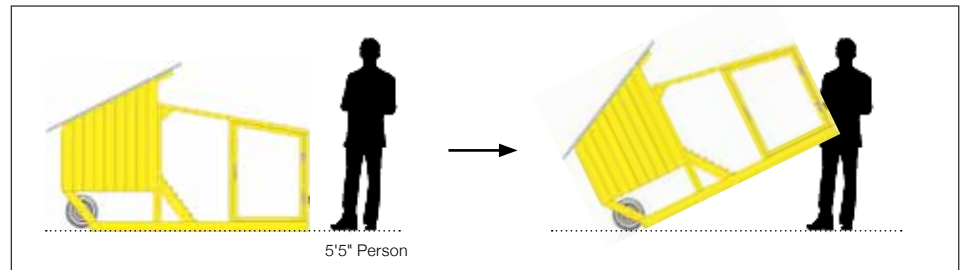

To move the coop to a new location, first remove the ramp and any other obstruction. Using the handles, lift to engage the back wheels. Move as needed.

CONGRATULATIONS. ENJOY YOUR NEW UPGRADED CHICKEN COOP!

Chicken Coop // Hack

GALLERY OF IMAGES

YellaWood
Pressure Treated Pine



Chicken Coop

FASTENER & HARDWARE INFORMATION



FOR INTERIOR OR EXTERIOR APPLICATIONS

Use fasteners and hardware that are in compliance with the manufacturer's recommendations and the building codes for their intended use. As with any good design and construction practices, treated wood should not be used in applications where trapped moisture or water can occur. Where design and/or actual conditions allow for constant, repetitive or long periods of wet conditions, only stainless steel fasteners should be used.

FOR EXTERIOR APPLICATIONS

The following minimum galvanization levels may be used for connectors, joist hangers, fasteners and other hardware that are placed in direct contact with exterior applications of micronized copper treated wood:

- **Fasteners** – nails, screws, etc. ASTM – A 153 (1 oz/ft²)
- **Hardware** – connectors, joist hangers, etc. ASTM – A 653 G90 (0.90 oz/ft²)

The effects of other building materials within a given assembly, along with environmental factors, should also be considered when selecting the appropriate hardware and fasteners to use for a given project containing treated wood.

Stainless Steel fasteners and hardware are required for Permanent Wood Foundations below grade and are recommended for use with treated wood in other severe exterior applications such as swimming pools, salt water exposure, etc. Type 304 and 316 are recommended grades to use.

ALUMINUM

Aluminum building products may be placed in direct contact with YellaWood® brand products used for interior uses and above ground exterior applications such as decks, fencing, and landscaping projects. Examples of aluminum products include siding, roofing, gutters, door and window trim, flashing, nails, fasteners and other hardware connectors. However, direct contact of treated products and aluminum building products should be limited to code-compliant construction applications that provide proper water drainage and do not allow the wood to be exposed to standing water or water immersion.

We recommend you contact the aluminum building products manufacturer for its recommendations regarding use of its aluminum products in contact with treated wood in ground contact applications or when exposed to salt water, brackish water, or chlorinated water, such as swimming pools or hot tubs.

Also check with the aluminum building products manufacturer regarding compatibility with other chemicals and cleaning agents and the use of their aluminum products in commercial, industrial, and specialty applications such as boat construction.

YellaWood® brand pressure treated products are treated with preservatives (the "Preservatives") and preservative methods and technologies of unrelated third parties. For details regarding the Preservatives, methods, and technologies used by Great Southern Wood Preserving, Incorporated, see www.yellowood.com/preservative or write us at P.O. Box 610, Abbeville, AL 36310. Ask dealer for warranty details. For warranty or for important handling and other information concerning our products including the appropriate Safety Data Sheet (SDS), please visit us at www.yellowood.com/warranties or write us at P.O. Box 610, Abbeville, AL 36310. YellaWood®, YellaWood Protector® and the yellow tag are federally registered trademarks of Great Southern Wood Preserving, Incorporated.

Great Southern Wood Preserving, Incorporated makes no warranties expressed or implied as to the fitness for a particular purpose of this plan.

Chicken Coop

IMPORTANT INFORMATION

YellaWood®
Pressure Treated Pine

- Consult the end tag to determine which preservative or preservative system was used in the treatment of that particular product. YellaWood® brand products may be used in direct contact with aluminum building products when limited to code-compliant construction applications that provide proper water drainage and do not allow the wood to be exposed to standing water or water immersion.
- Use fasteners and other hardware that are in compliance with building codes for the intended use.
- Do not burn preserved wood.
- Wear a dust mask and goggles when cutting or sanding wood.
- Wear gloves when working with wood.
- Some preservatives may migrate from the treated wood into soil/water or may dislodge from the treated wood surface upon contact with skin.
- Wash exposed skin areas thoroughly.
- All sawdust and construction debris should be cleaned up and disposed of after construction.
- Wash work clothes separately from other household clothing before reuse.
- Preserved wood should not be used where it may come into direct or indirect contact with drinking water, except for uses involving incidental contact such as fresh water docks and bridges.
- Do not use preserved wood under circumstances when the preservative may become a component of food, animal feed or beehives.
- Do not use preserved wood as mulch.
- Only preserved wood that is visibly clean and free of surface residue should be used. If the wood is to be used in an interior application and becomes wet during construction, it should be allowed to dry before being covered or enclosed.
- Mold growth can and does occur on the surface of many products, including untreated and treated wood, during prolonged surface exposure to excessive moisture conditions. To remove mold from the treated wood surface, wood should be allowed to dry. Typically, mild soap and water can be used to remove remaining surface mold. For more information visit www.epa.gov.
- Projects should be designed and installed in accordance with federal, state and local building codes and ordinances governing construction in your area, and in accordance with the National Design Specification (NDS) and the Wood Handbook.

DISPOSAL RECOMMENDATIONS

Preserved wood may be disposed of in landfills or burned in commercial or industrial incinerators or boilers in accordance with federal, state and local regulations.